

# 13

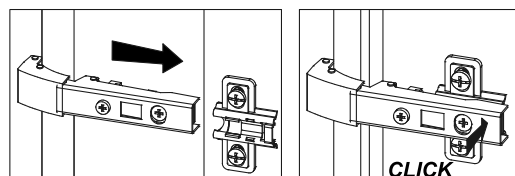

# MODELL: SB6

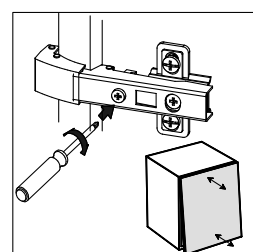
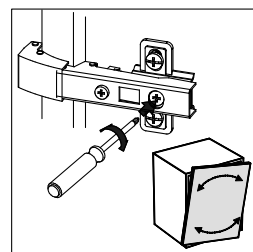
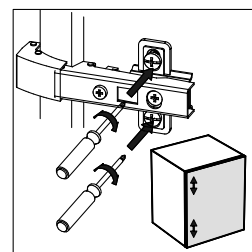
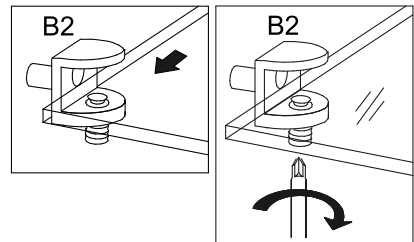
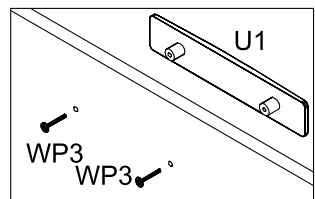
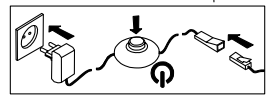
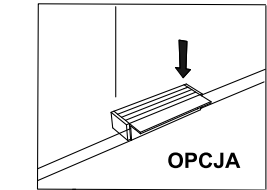
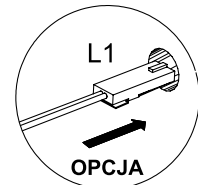
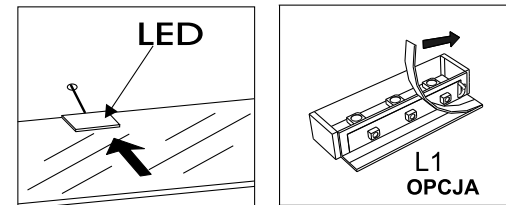
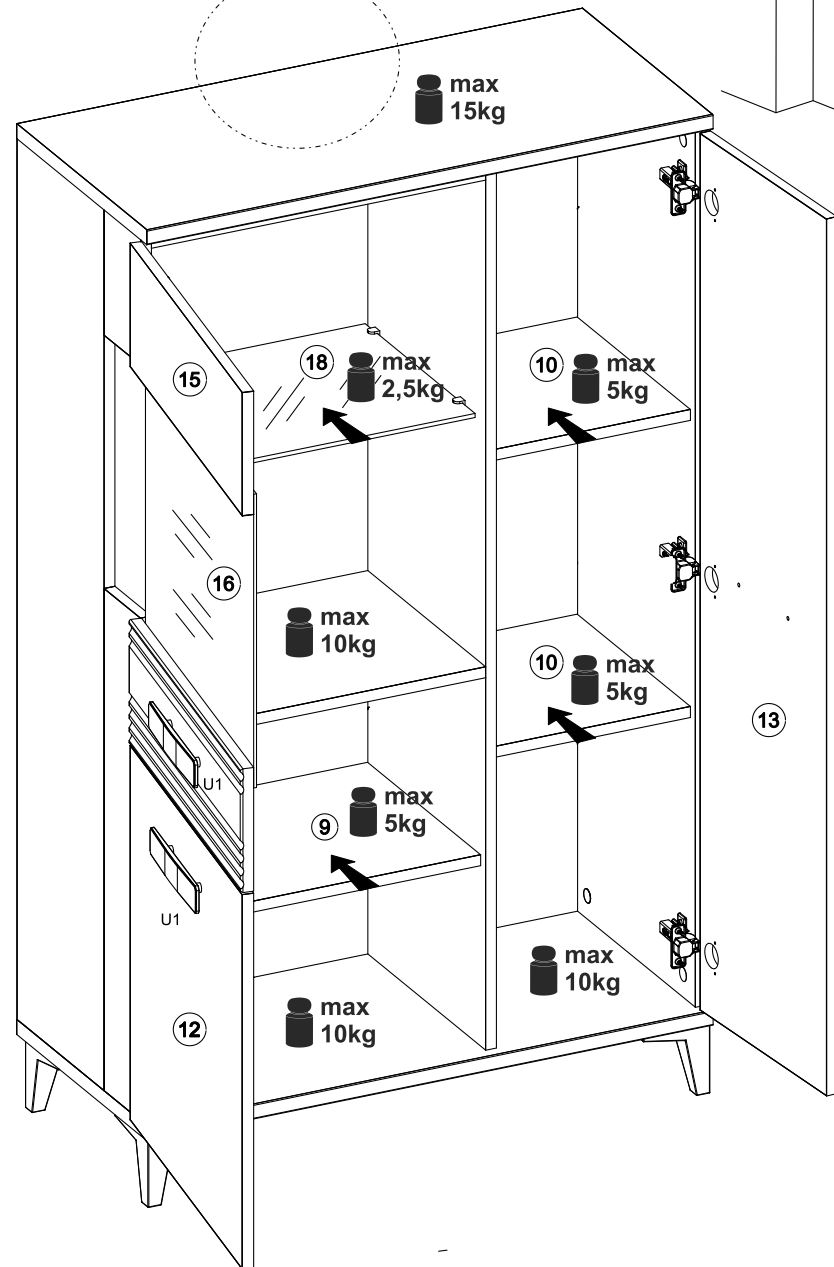
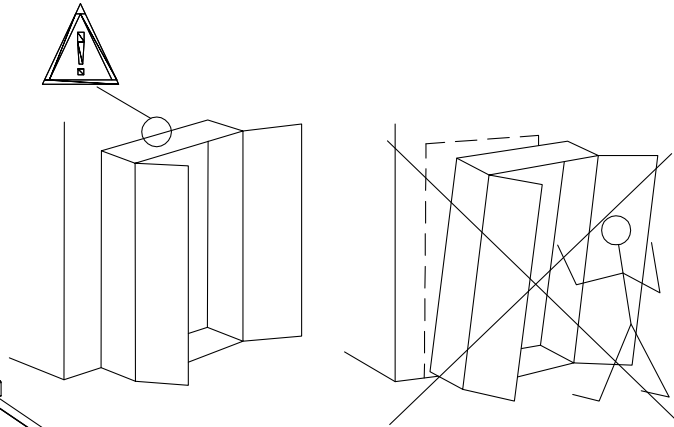
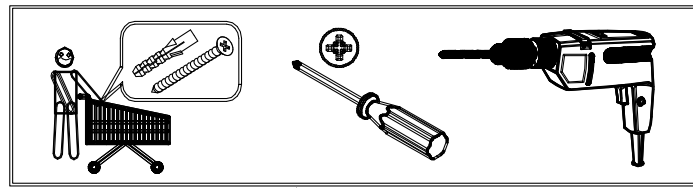
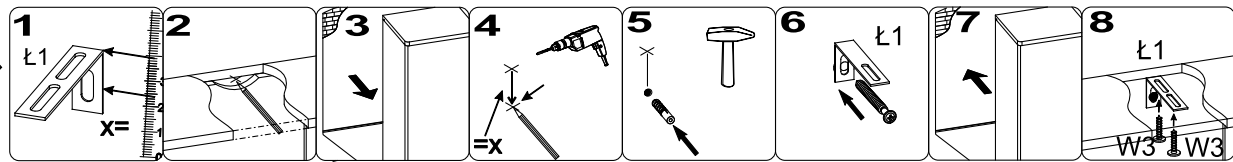
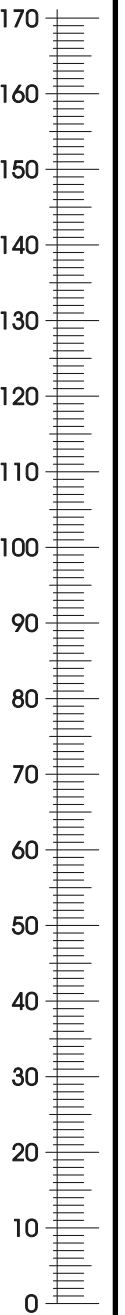
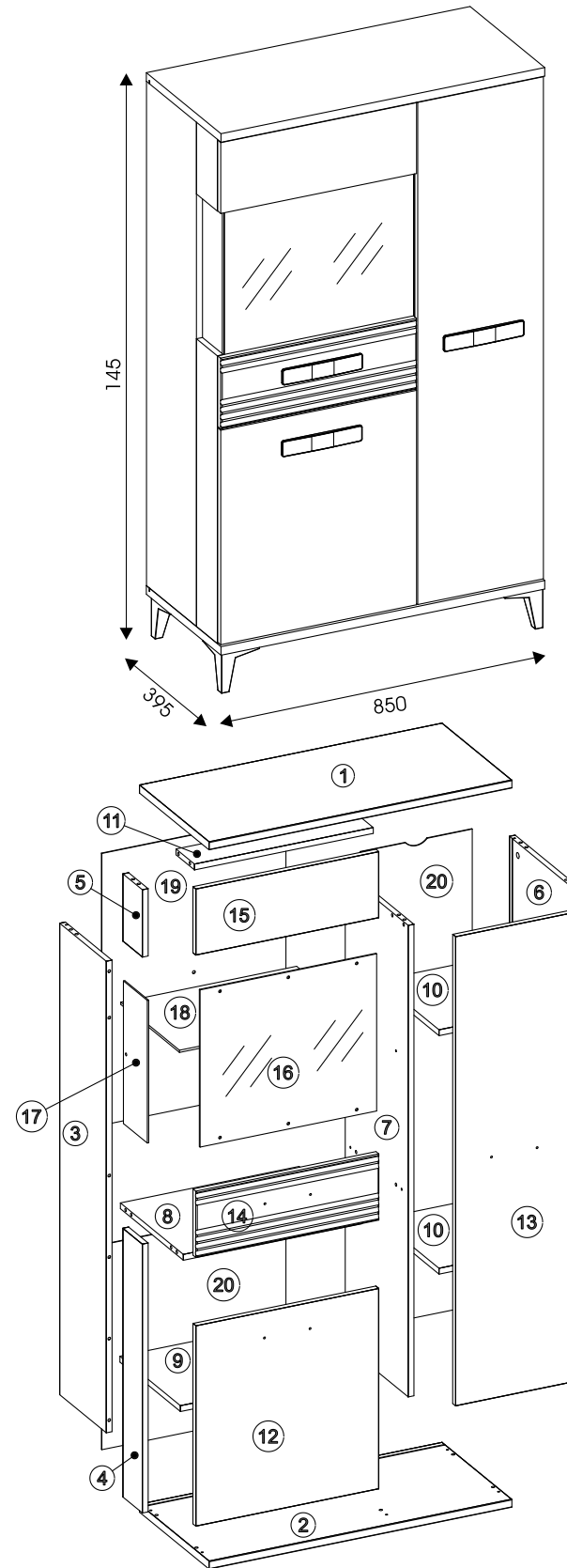
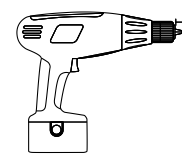
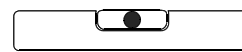
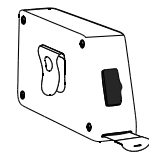
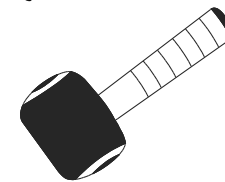
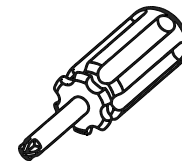
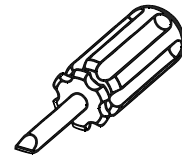
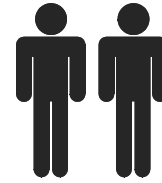
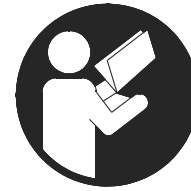

20	517x563	3/3
20	1311x314	3/3
19	747x517	3/3
18	494x330	1/3
17	392x134	3/3
16	432x496	3/3
15	514x182	3/3
14	514x182	3/3
13	1290x330	3/3
12	514x551	3/3
11	502x104	2/3
10	298x340	1/3
9	501x340	1/3
8	502x354	1/3
7	1296x354	2/3
6	1296x372	2/3
5	185x110	2/3
4	739x110	2/3
3	1296x262	2/3
2	850x392	1/3
1	850x392	1/3

7x ZC0	16x 5x20 W5	1x L1	1x OPCJA 1xNSP-3D/WW L1						
26x #20/863 ZN1	16x 3.5x16 W3	14x ST1	4x B2	8x TU1	14x 3x20 W9	7x H=0 PRO	6x 4x27 WP3	4x N1	
5x 56 T3	20x 8x30 K1	3x U 1	8x 4x16 WP4	26x #15/15 M1	16x DU232T T1	10x BS1	10x 2x20 G1	12x B1	

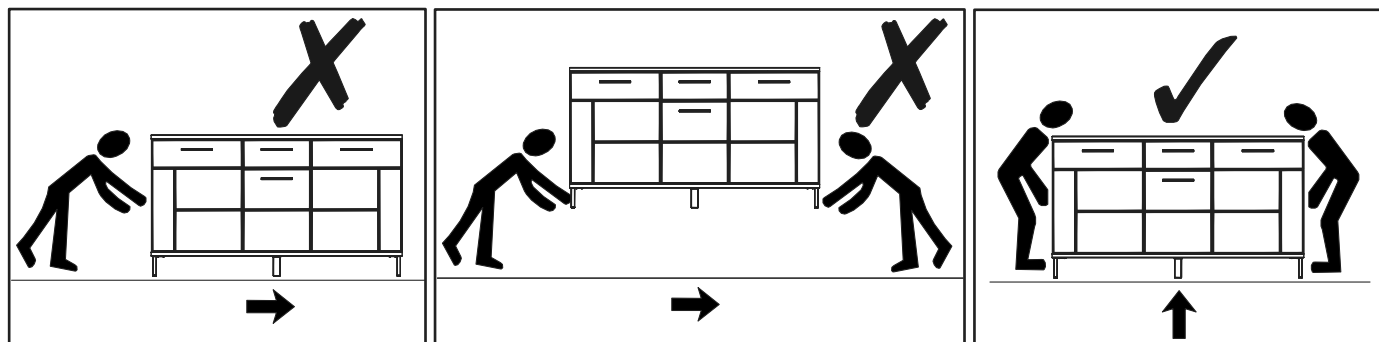

# 11

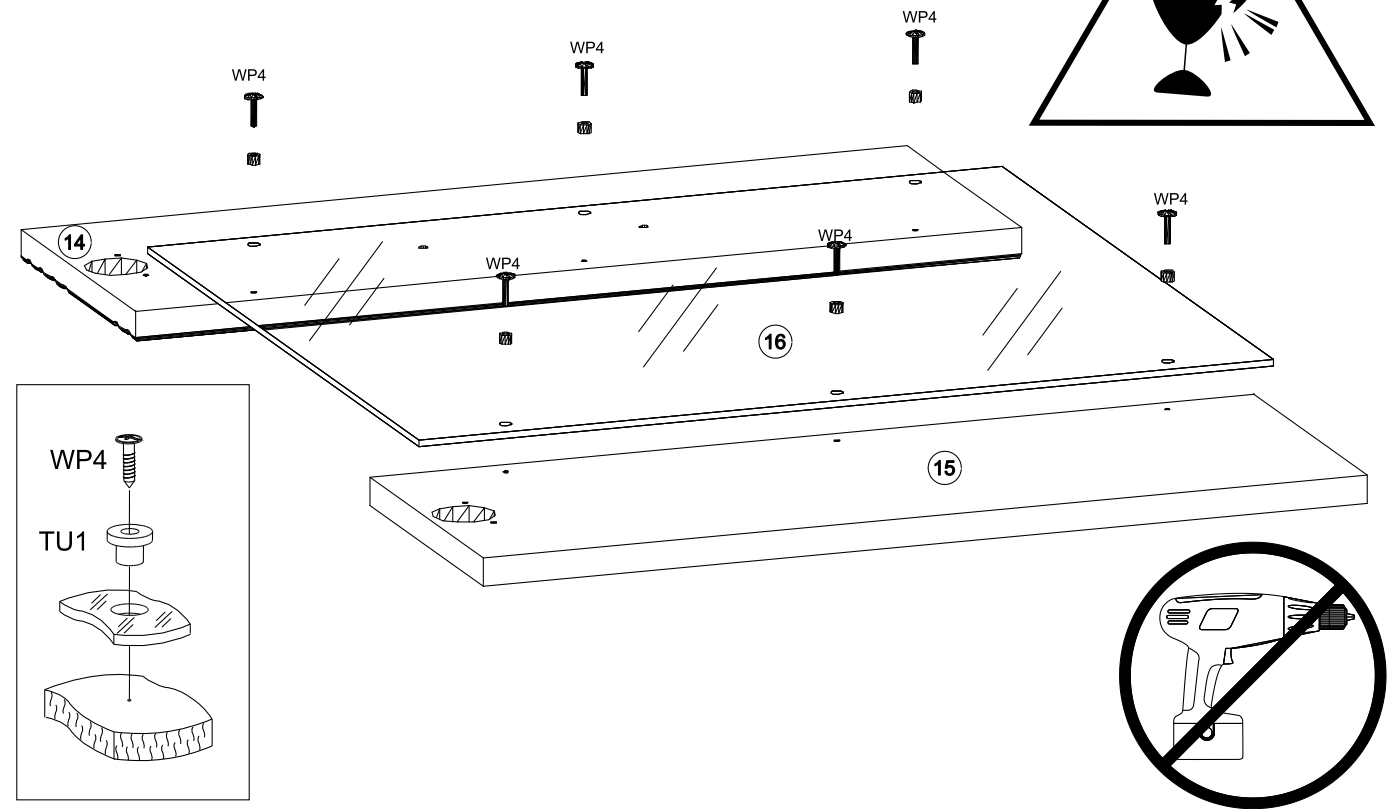

# 12

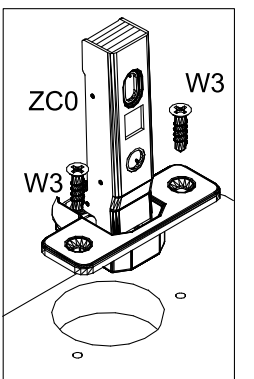
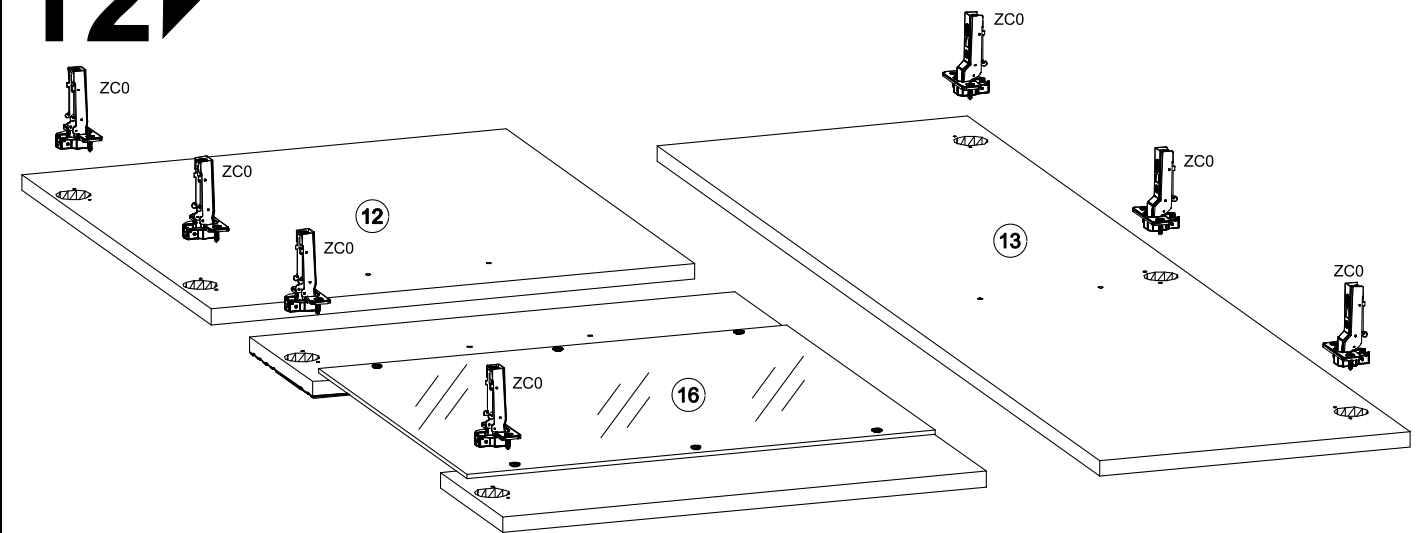

9▶

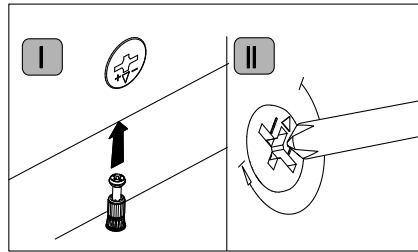
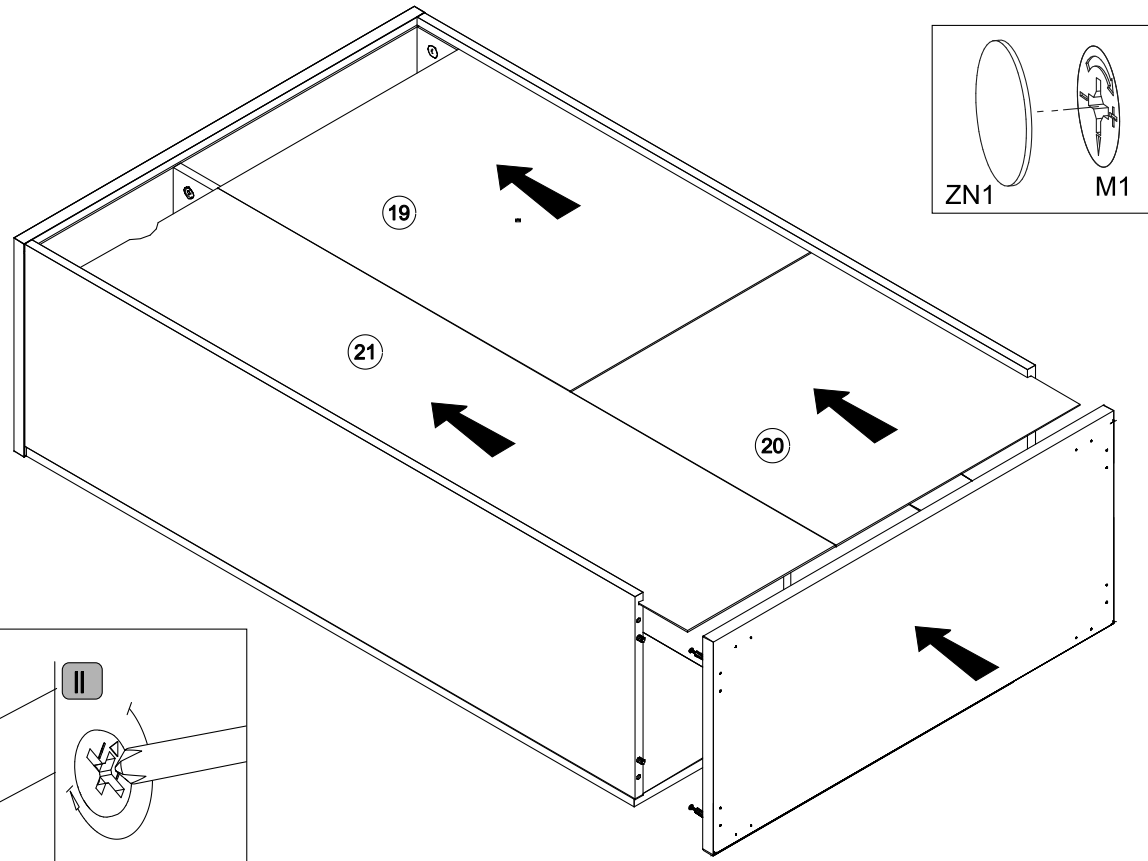

10▶

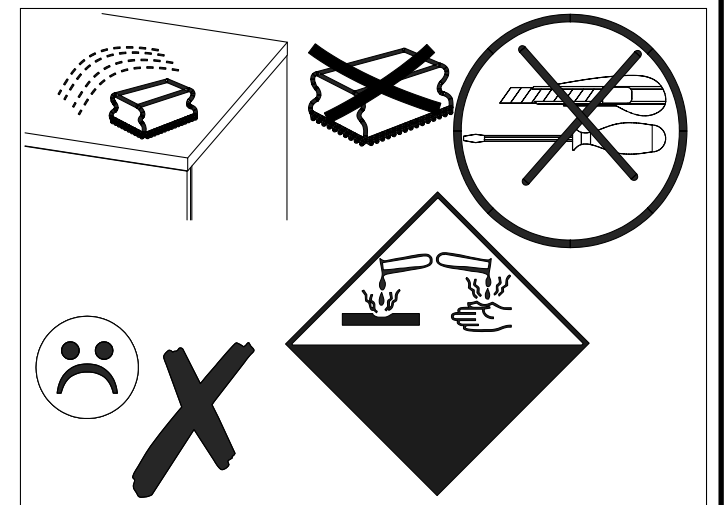
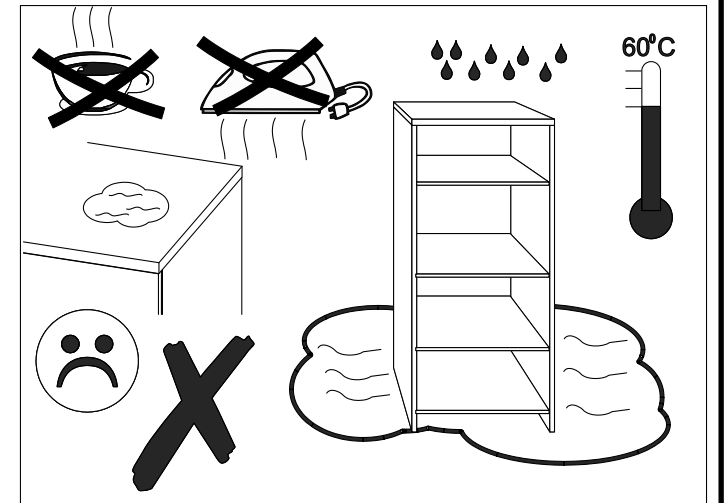
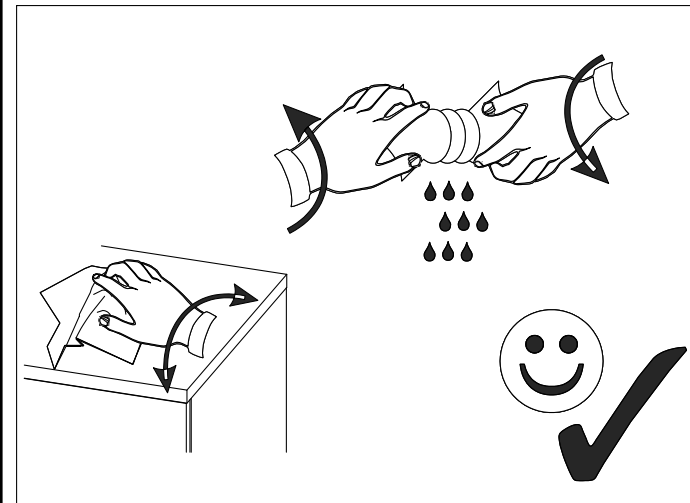
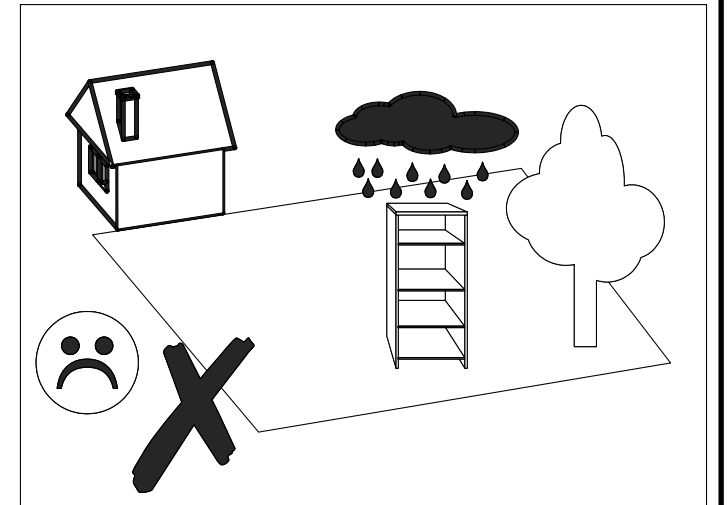
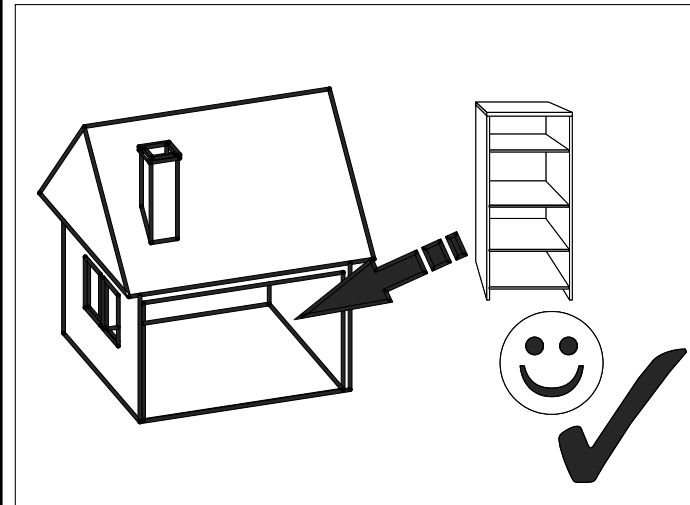
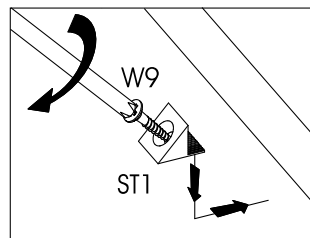
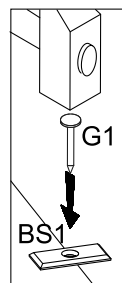
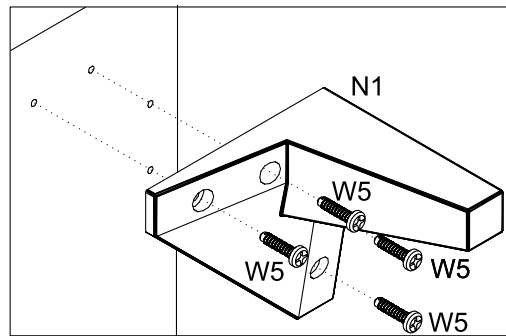
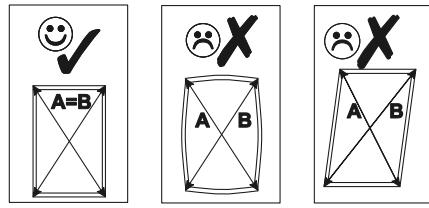
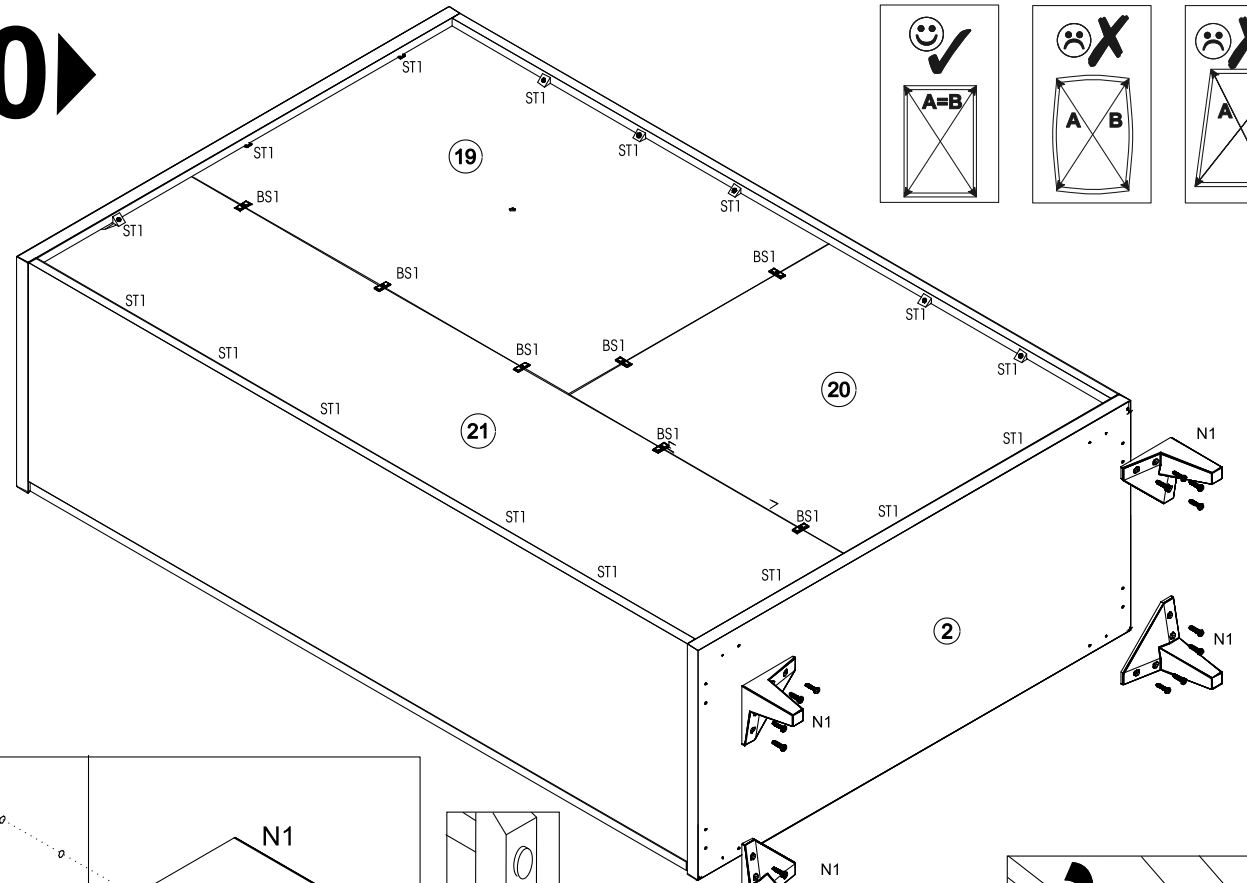

1▶

SB6

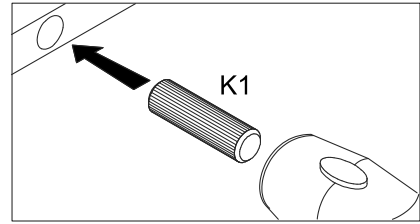
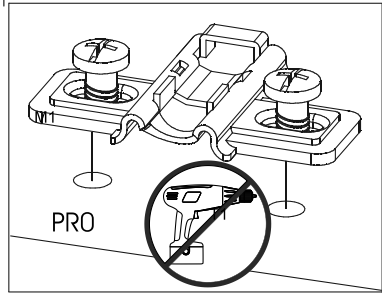
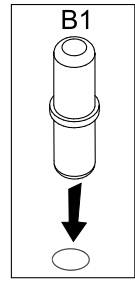
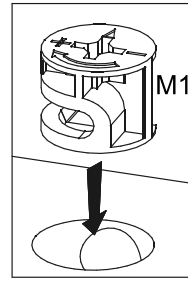
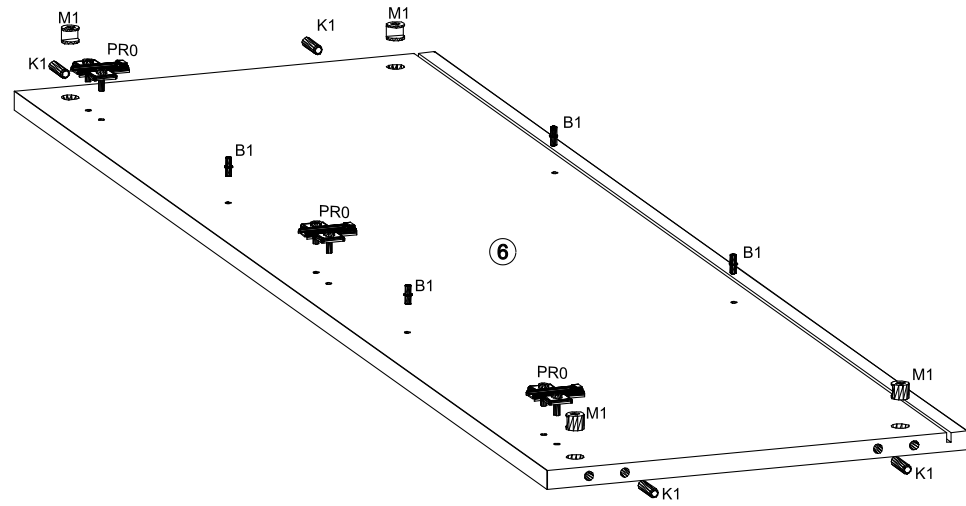

7▶

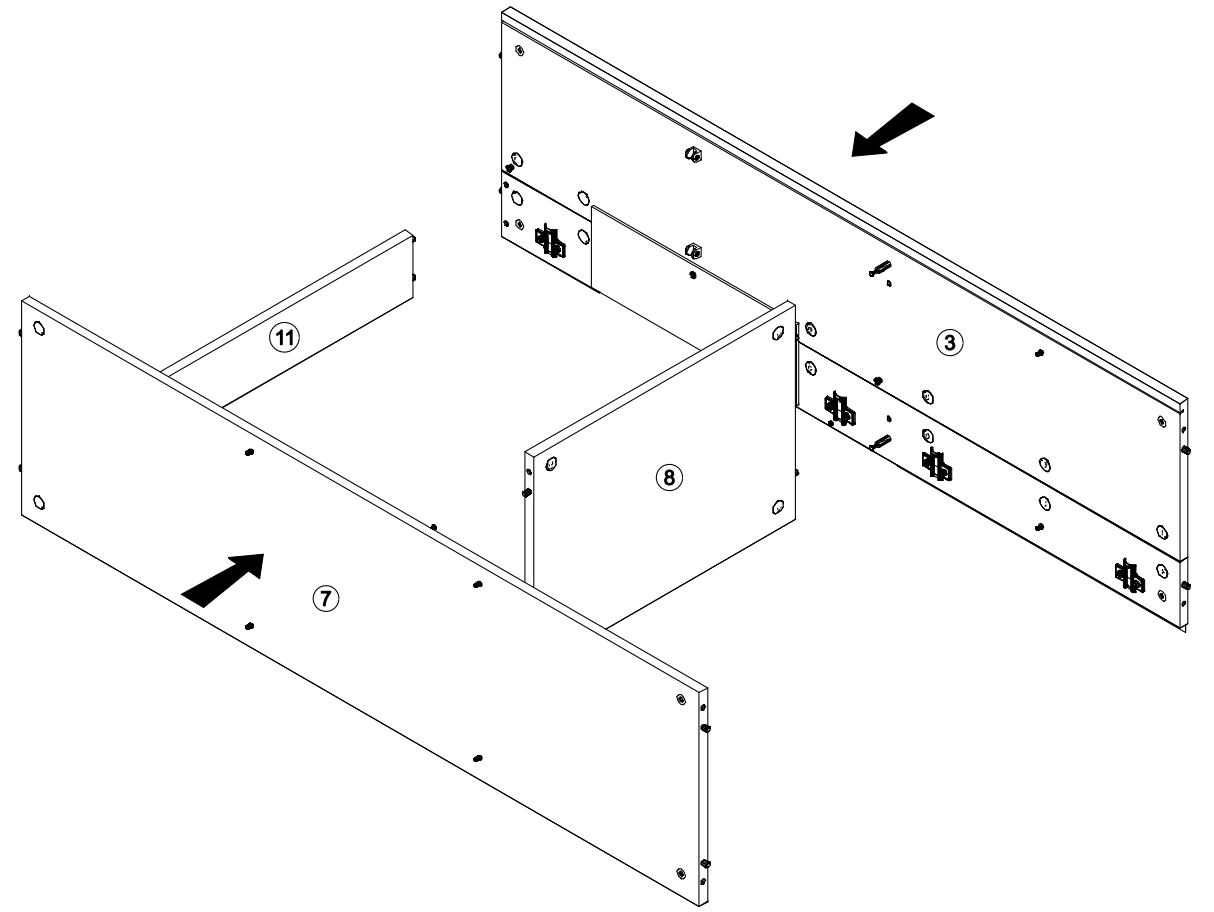

2▶

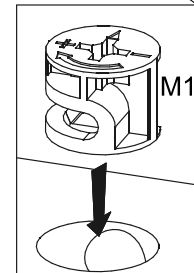
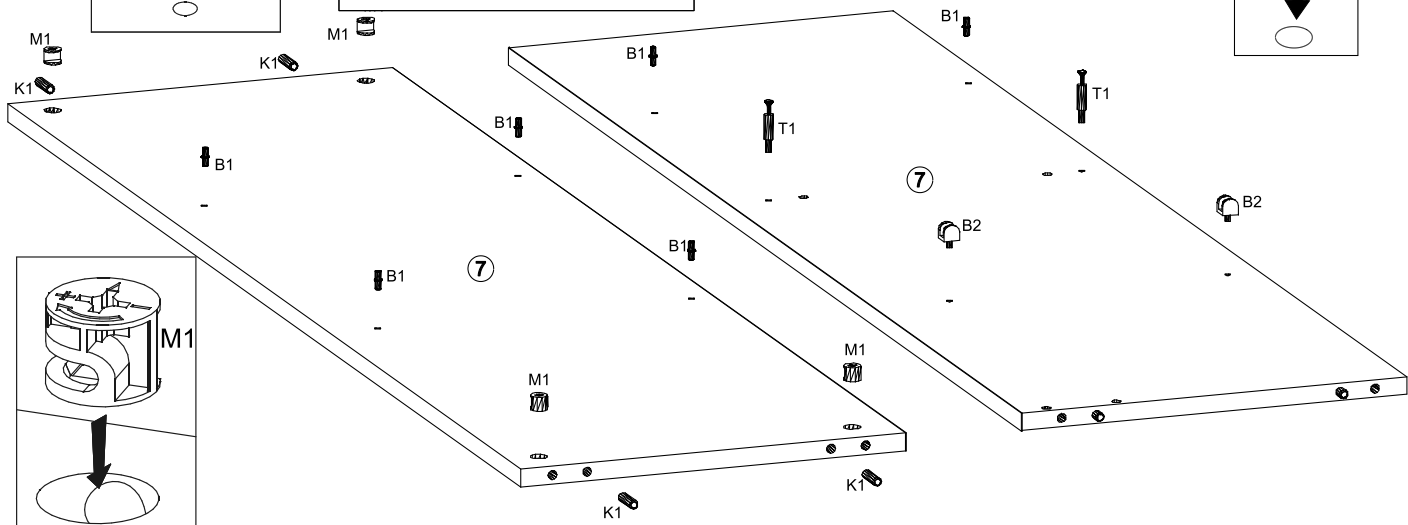
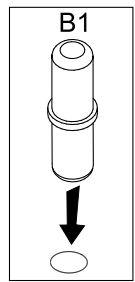
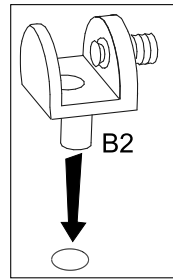
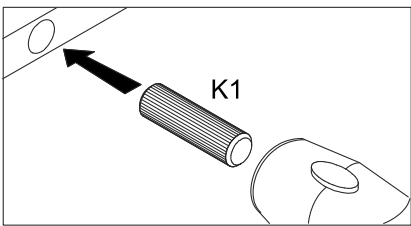
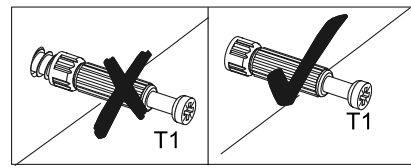
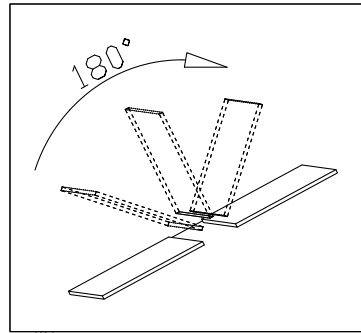
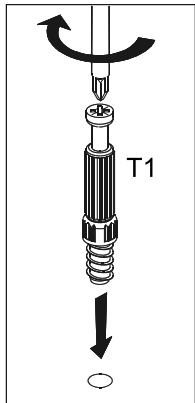

8▶

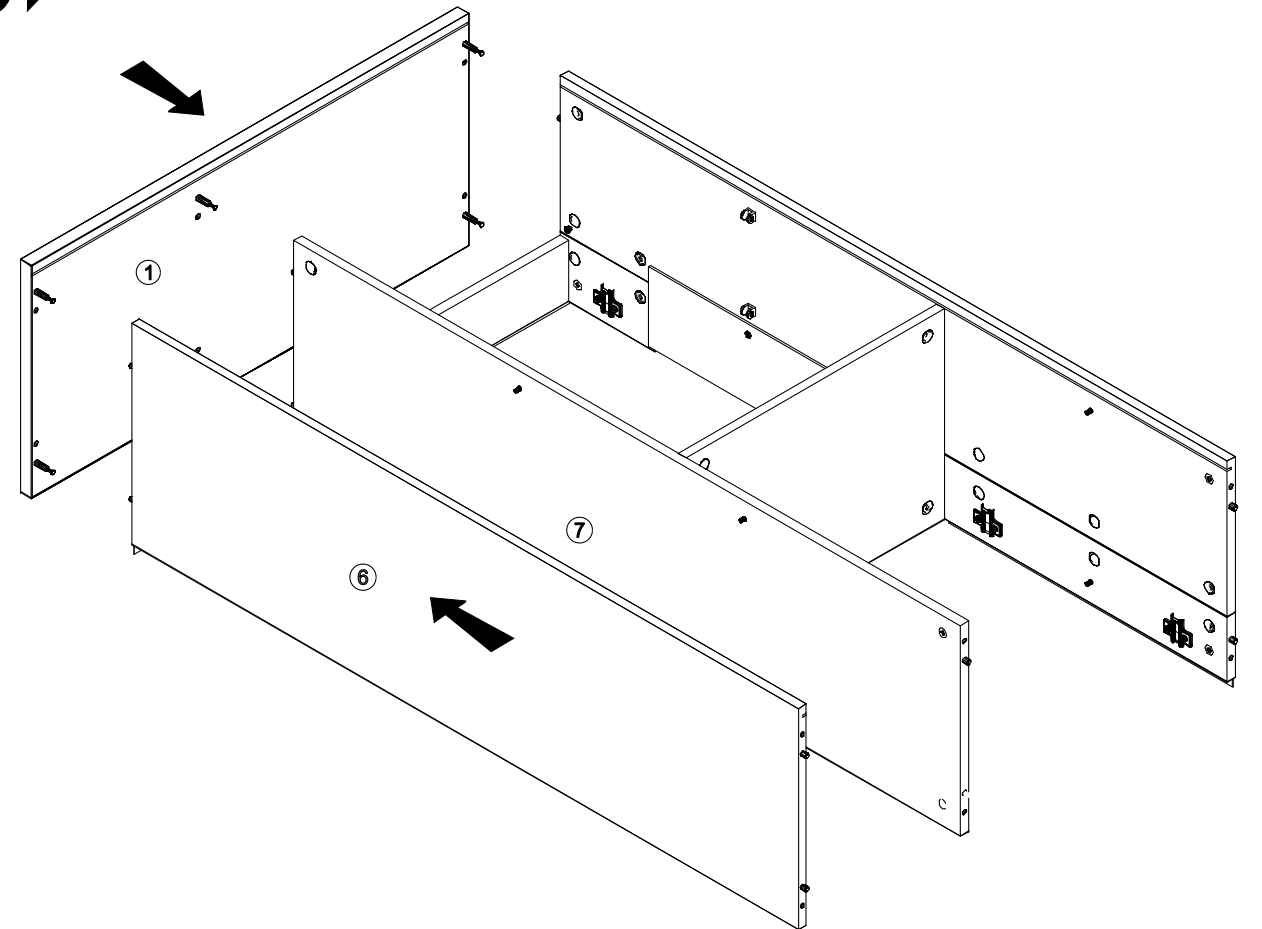



**3**

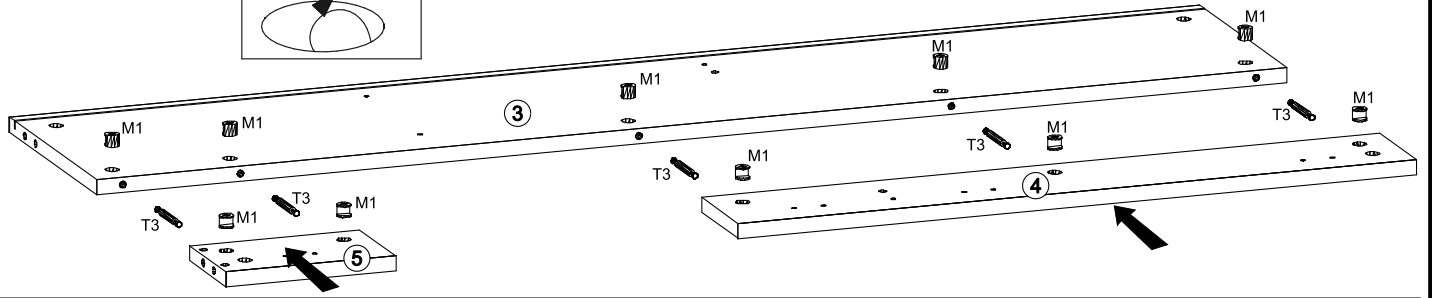
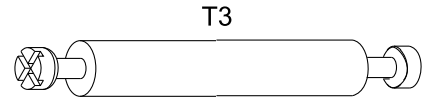
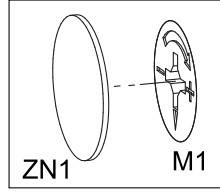
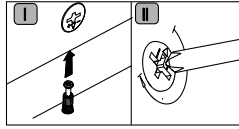
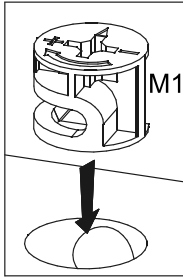

**4**

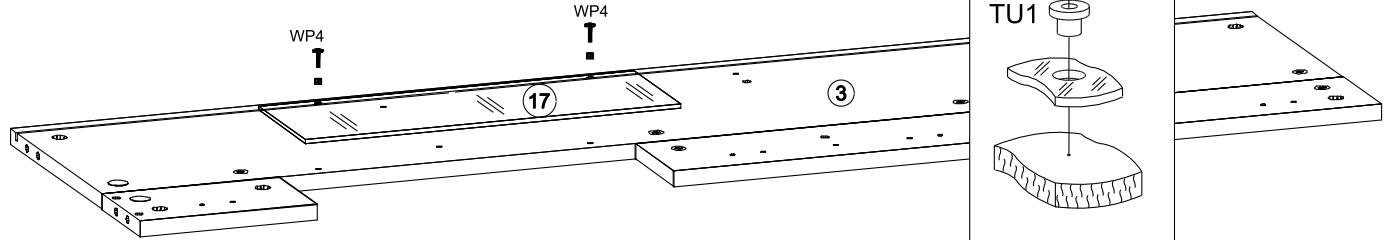
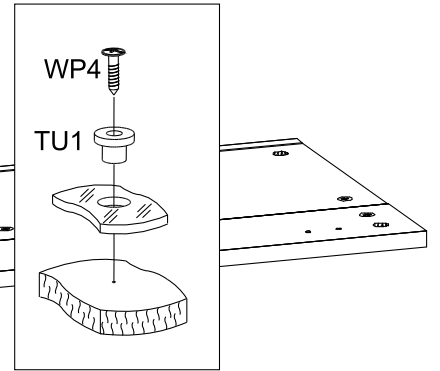
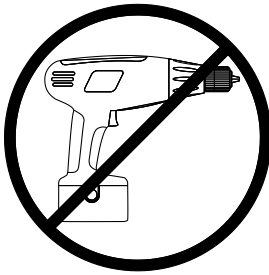

**5**

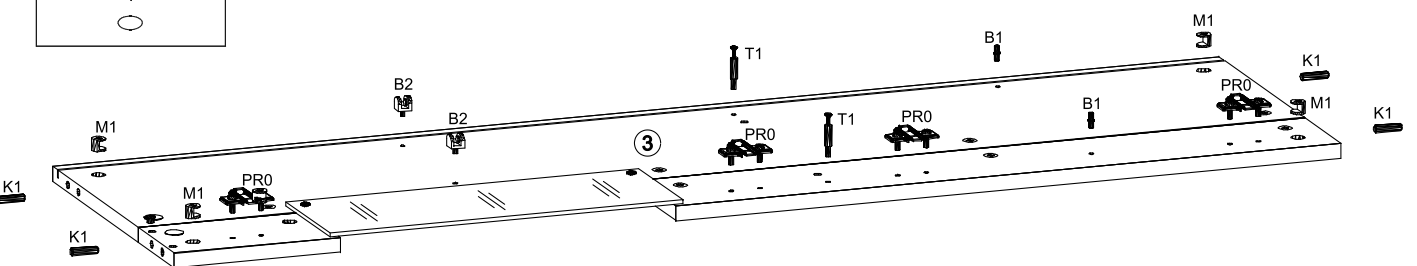
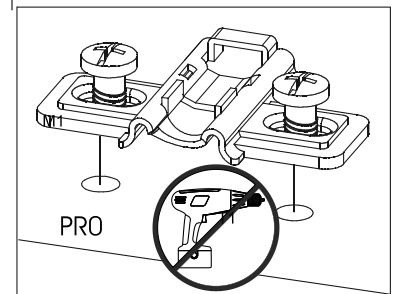
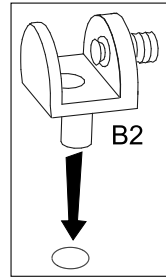
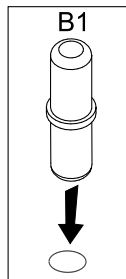
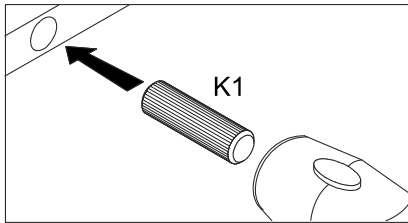
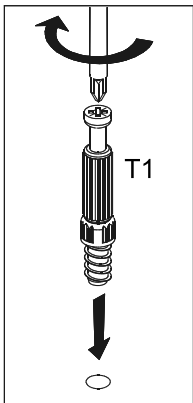
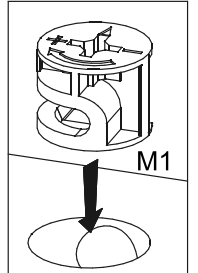
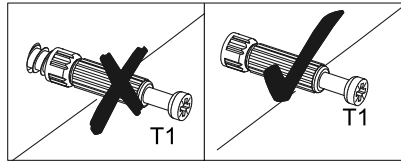

# 6

# SB6

