

GR8

- (PL)** Instrukcja montażu
- (D)** Montageanleitung
- (GB)** Assembly instructions
- (ES)** Instrucciones de instalación
- (FR)** Instructions de montage
- (CZ)** Montážní návod
- (UA)** Інструкція монтажу
- (HU)** Összeszerelési útmutató
- (SK)** Montážny návod
- (RU)** Инструкции по монтажу
- (IT)** Istruzioni di montaggio
- (RO)** Instructiuni de asamblare
- (TR)** Montaj talimati
- (NL)** Handleiding voor de montage

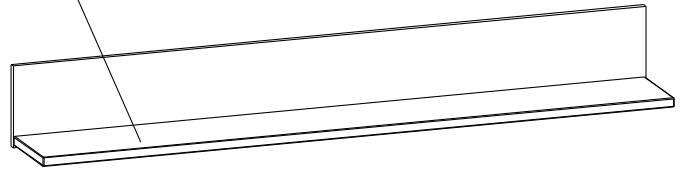
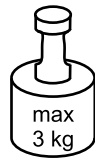

1550x210x195

Lp.	
2	1545x195
1	1547x195

1

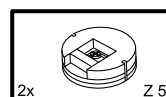
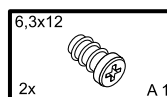
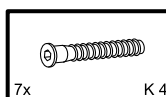
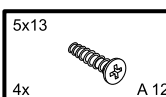
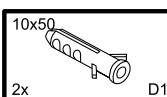
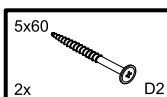
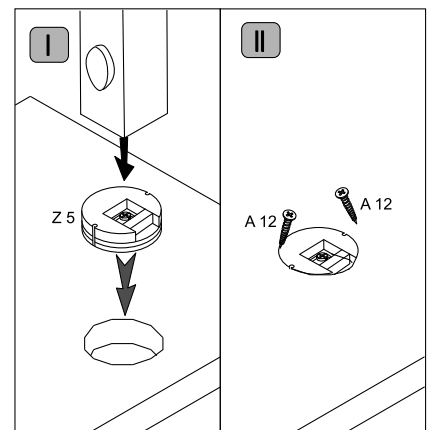
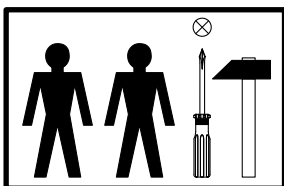
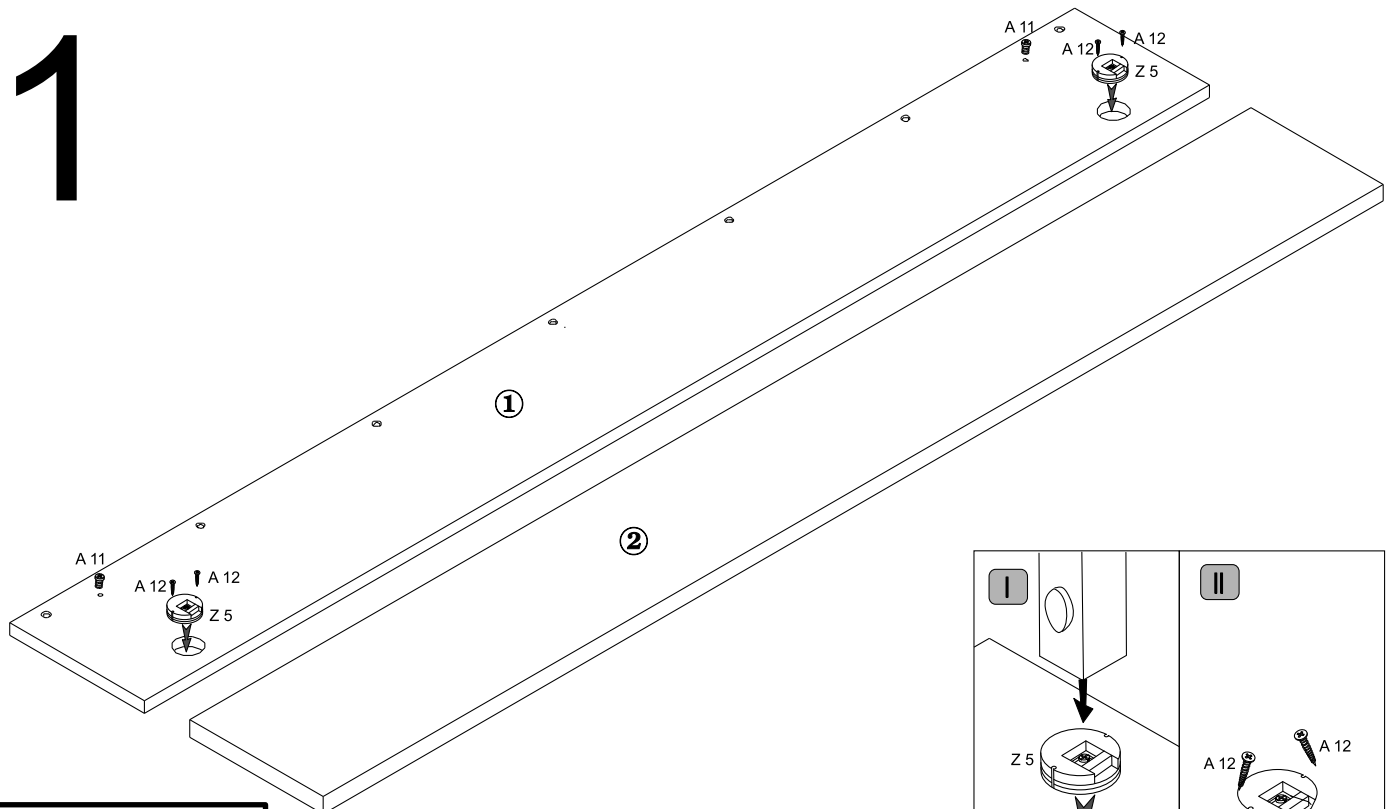

2

